

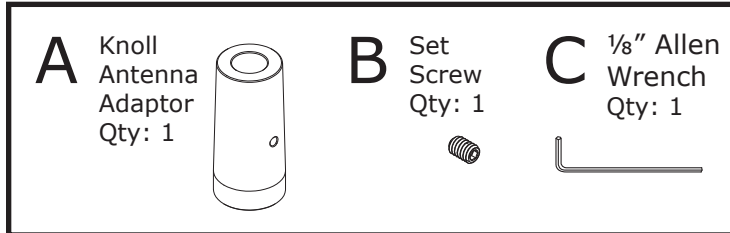

Assembly Instructions: Knoll® Antenna® Adaptor MON-ADPTKA-W-S

Parts



Required, Sold Separately

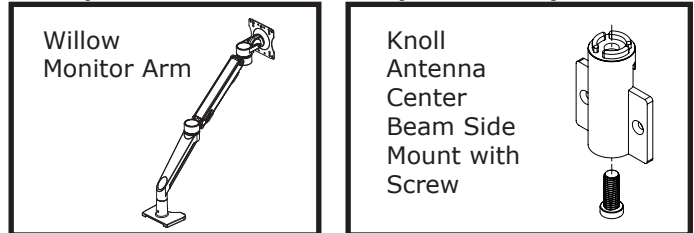

Verify that you have all the hardware and tools needed for the assembly.

1/8" Allen wrench (C) provided 
 7/32" Allen wrench from Willow hardware kit
 Tool specified for Knoll Antenna Center Beam Side Mount screw from manufacturers instructions

1 Disassemble Willow Monitor Arm to Remove Base

- a** Remove Willow Monitor Arm from the base by removing the Pivot Cover Cap and using the 7/32" Allen Wrench from the Willow hardware kit, unscrew the Round Head Cap Screw until screw detaches from Base.
- b** Remove and set aside the Pivot Cap, Button Head Allen Cap Screw, Steel Washer, Willow Arm Assembly, Plastic Pivot Washer and Pivot Pin.
- c** Remove the C-Clamp or Grommet Base.

***Note:** You may need to loosen the Base Set screw to remove the Base.

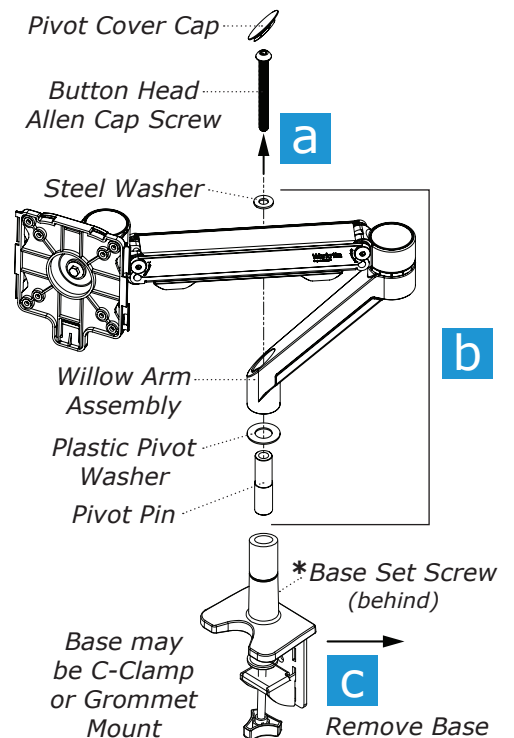

2 Remove Antenna Center Beam Side Mount From Center Beam

If installed, remove the Knoll Antenna Center Beam Side Mount from the Center Beam according to Manufacturer instructions. You will need to access the bottom of the unit to attach the adaptor.

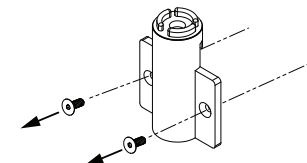

3 Attach Knoll Antenna Adaptor to the Center Beam Side Mount

Place the Antenna Adaptor (A) onto the Knoll Center Beam Side Mount. Use the bottom screw from the Antenna System to affix the Center Beam Side Mount to the Antenna Adaptor.

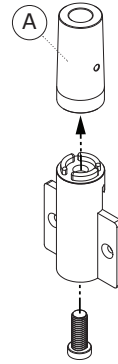

4 Re-Attach Center Beam Side Mount With Antenna Adaptor to Center Beam

Use the screws supplied with Antenna System to re-attach the Center Beam Side Mount unit with the Antenna Adaptor to the Center Beam of the Antenna System.

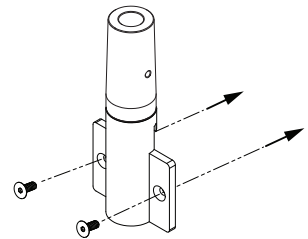

5 Reassemble and Mount Willow Monitor Arm to Antenna Adaptor

- a** Place Pivot Pin into the Antenna Adaptor, add the Plastic Pivot Washer, then the Willow Monitor Arm and Steel Washer.
- b** Attach Monitor arm assembly to Antenna System with the Button Head Allen Cap Screw using the $7/32$ " Allen Wrench and cap off with the Pivot Cover Cap.
- c** Insert and tighten Set Screw (B) with the $1/8$ " Allen Wrench (C) to lock monitor arm on Antenna Adaptor.

